

**A1+**  
**ACOUSTIC**

USER MANUAL

[www.laney.co.uk](http://www.laney.co.uk)



British Engineering from the  
Black Country United Kingdom



## WELCOME

Dear Player,

Thank you very much for purchasing your new Laney product and becoming part of the worldwide Laney family. Each and every Laney unit is designed and built with the utmost attention to care and detail, so I trust yours will give you many years of enjoyment.

Laney products have a heritage which stretches back to 1967 when I first began building valve amplifiers in my parent's garage.

Since then we have moved on from strength to strength developing an extensive range of guitar, bass, public address and keyboard amplification products along with a list of Laney endorsees that includes some of the world's most famous and respected musicians.

At the same time we believe we have not lost sight of the reason Laney was founded in the first place - a dedication to building great sounding amplification for working musicians.

Warm Regards,

A handwritten signature in black ink, appearing to read 'Lyndon Laney', with a stylized flourish at the end.

Lyndon Laney CEO

The AI + is a dedicated 80 watt acoustic amplifier - designed to give the acoustic guitar player the most authentic electric reproduction of an acoustic instrument possible.

Capable of producing the wide variety of sparkling high, luscious mids and tone full lows associated with high quality acoustic instruments. The AI+ is ideal for the singer songwriter who demands outstanding performance for both guitar and vocals.

The AI+ is a kick back style amp design, making it ideally suited to operate as your main sound source on stage in a conventional position or up close and personal kicked back as your stage monitor. The AI+ can also be mounted onto a pole stand by using the provided top hat in the base of the unit, giving you additional options.

The AI+ preamp houses two channels each containing everything we think you'll need in order to get a great sound. The driver

compliment consists of a specially developed 8" Bass Driver and a 1" Dome Tweeter, ensuring that the natural acoustic tones your guitar produces will be reproduced faithfully by the AI+.

The AI+ is finished in a stylish, textured Polyurethane coating and a foam fronted metal grille creating a very stylish and rugged amplifier which will continue to look good gig after gig,

Because the AI+ has been designed by gigging musicians we understand that it is important to be able to rely on your amplifier and to make sure that's the case every AI+ is extensively tested both electronically and by a player before it is shipped out. We are happy that your AI+ will give you years of trouble free service.

All the features & controls are covered over the next few pages, please take time to read this manual fully as it will allow you to get the very best from your amplifier, read on, play and enjoy..



## FRONT PANEL CONTROLS

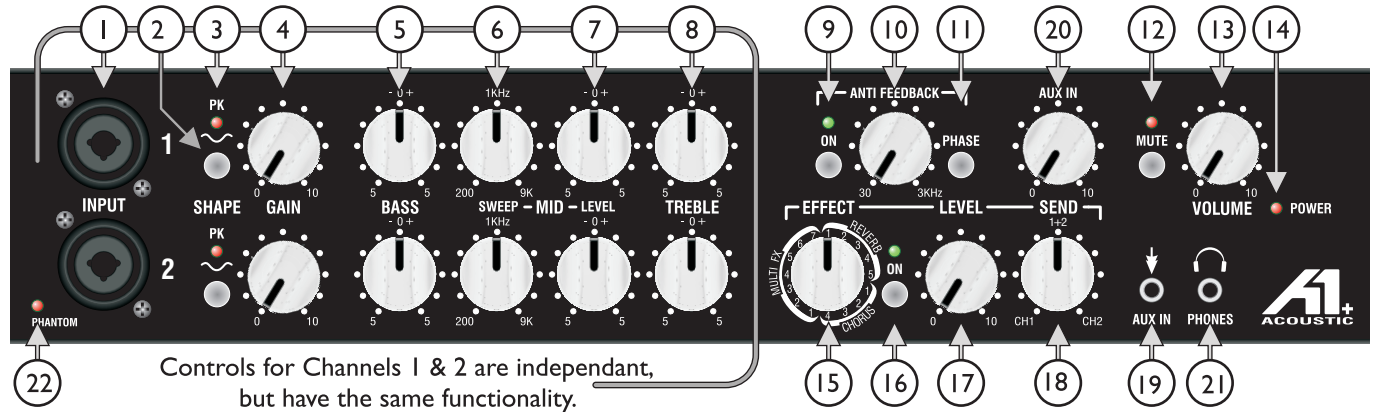

Controls for Channels 1 & 2 are independant,  
but have the same functionality.

- ① Combi Socket (for use with either XLR or 6.3 Jack) is provided for connecting your instrument or microphone. Only use good quality screened cable.
- ② Engages an EQ pre-shape circuit to give a natural Mid cut, Bass & Treble Boost sound.
- ③ Lights when peak levels are reached. To give optimum levels adjust Gain(4) till the peak LED just illuminates on the very loudest passages. (After adjusting the EQ it may be necessary to readjust Gain)
- ④ Controls the level of preamp gain on the channel. Turning this control clockwise will add more gain to your guitar signal, use this in conjunction with Volume (13) to achieve the correct volume and gain level you require.
- ⑤ Active Bass control allowing boost and cut of the low-frequency response of the pre-amplifier. To give optimum levels adjust gain till the peak LED just illuminates on the very loudest passages.
- ⑥ Selects the mid-frequencies (200Hz to 9KHz) to be cut or boosted in conjunction with the paramid level control (7)
- ⑦ Boosts or cuts the chosen frequency set by (6). To boost the chosen frequency turn the control clockwise, to cut the chosen frequency turn anticlockwise.

- ⑧ Active Treble control allowing boost or cut of the high frequency response of the pre-amplifier.
- ⑨ Anti-Feedback control can be switched in and out here and adjusted with (10) to eliminate the "body resonance" feedback often associated with amplified acoustic guitars at high volume levels.
- ⑩ To eliminate "body resonance" feedback, switch the filter in with (9) and adjust this control until the body resonance reduces; you should find a "sweet spot on" the control where it disappears. Turning further out of the sweet spot will bring the resonance back up again. This setting will be the optimum for that particular guitar but may need to be altered if you plug in another guitar.
- ⑪ Switches the phase of the signal from the amplifier. When you play any acoustic guitar the sound it produces is a waveform, the same applies to an acoustic guitar plugged into an acoustic amplifier. It is not uncommon for these two waveforms - which occur simultaneously, to be out of phase with each other. To a player who is sat close to an amplifier this poses a small problem if the wave forms are out of phase as they are destructive to each other and cancel each other out. This would cause the guitar to sound a little thin and lack lustre. Engaging the phase switch switches the phase of the amplified signal removing the problem of destructive interference. However sometimes the low frequencies being in phase can cause acoustic feedback problems, to avoid this try operating the phase reversal switch. Most times this will cure the problem. One thing to point out is that the audience does not hear any phase problems as by the time the sound wave reaches them any phase differences have been cancelled out naturally.
- ⑫ Mutes the amplifier. LED is flashing when muted.
- ⑬ Sets the overall listening volume of the amplifier.
- ⑭ When illuminated indicates that power is connected to the unit and it is ready to go.
- ⑮ ⑱ Effects Control Set: See pages 8-9 for detail of their operation.
- ⑲ ⑳ A 3.5mm Stereo line input for connection of a CD/MP3 player as a backing track. Control the level of the input using the Level control (20).
- ㉑ Socket for connecting a pair of quality headphones. When in use, the internal loudspeaker is automatically muted.
- ㉒ Lights when Phantom Power has been applied to Channel 2. (See rear panel controls).

**(ALWAYS SWITCH OFF AND DISCONNECT THE POWER CORD WHEN NOT IN USE)**

# REAR PANEL CONTROLS

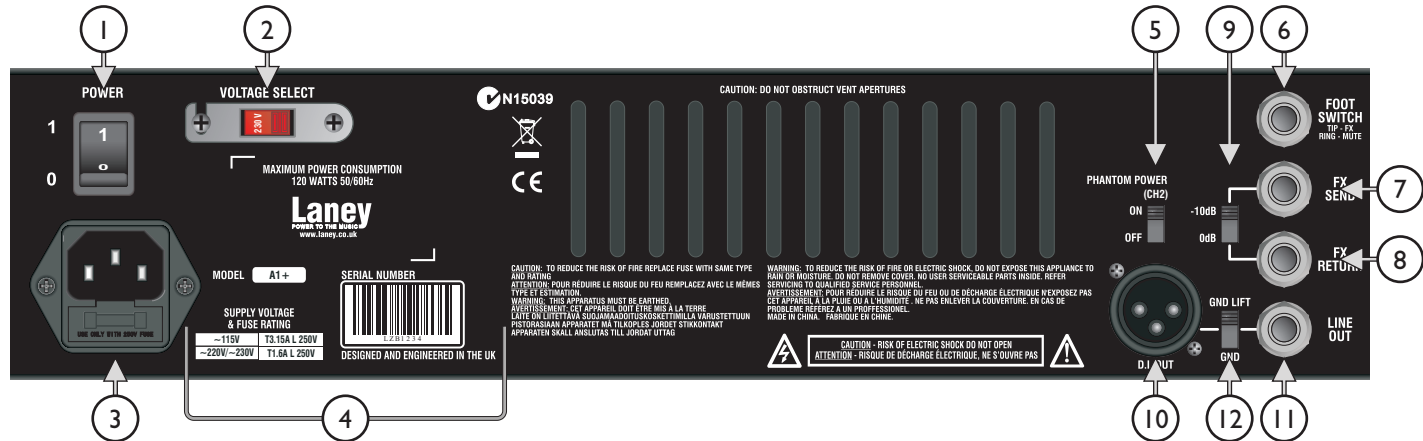

- ① Mains Power Switch.
- ② Voltage Selection Switch: This is factory set to the correct voltage for the region the product is supplied to. If necessary it can be reset by removing the mains lead and then loosening (but not removing) the screws securing the cover. The cover can then be pivoted away from the switch which can be moved to select the alternate voltage. **DO NOT** reconnect the mains lead until the cover is replaced and secured. It is essential to ensure that the correct fuse is fitted (as printed on the panel) for the voltage being used.

- ③ Power inlet socket. Connect to your power source. Make sure the specified voltage is correct for your country!

**IMPORTANT:** The main safety fuse for the unit is inside this drawer.

**USE ONLY THE CORRECT SIZE AND RATING OF FUSE AS SPECIFIED ON THE PANEL.**

- ④ Information area relating to the amplifier: Serial Number; Fuse Type & Rating etc
- ⑤ Turns on a phantom power supply to Channel 2 (CH2), LED (22) on the front panel is lit when ON.

**(IMPORTANT: Only use for Microphones requiring Phantom Power!)**

- ⑥ Connect a Laney FS2 footswitch here, FX Mute (Tip) & Master Mute (Ring).

**TIP**

(FX Mute & Master Mute front panel switches must be enabled before they can be operated from the footswitch).

**TIP**

- ⑦ FX SEND: Mono jack socket for connection to the input of an external FX unit.
- ⑧ FX RETURN: Mono jack socket for the connection of the output of an external FX unit.
- ⑨ FX LOOP SWITCH: Selects the FX Loop mode of operation:
  - -10dBu - For connection of FX units with a -10dBu nominal output level. As this is intended for devices with a lower output level, this switch increases the gain of the FX Loop by 10dB.
  - 0 dBu - For connection of FX units with a 0dBu nominal output level.
- ⑩ This socket provides a balanced output for direct injection of the amplifier signal into a PA System or Recording Device. The signal is taken pre-master volume.
- ⑪ Line out socket, to connect to another power amp etc., line level signal is taken post master volume.
- ⑫ If a hum loop is experienced when other equipment is connected to the D.I. or the Line Out socket, use this switch to reduce or remove it completely.

**TIP** **Amplifier connection:** In order to avoid damage, it is advisable to establish and follow a pattern for turning on and off your equipment. With all system parts connected, turn on source equipment, tape decks, cd players, mixers, effects processors etc. **BEFORE** turning on your amplifier. Many products have large transient surges at turn on and off which can cause damage to your speakers. By turning on your amplifier **LAST** and making sure its Volume control is set to minimum any transients from other equipment will not reach your loudspeakers. Wait until all system parts have stabilised; usually a couple of seconds. Similarly when turning off your system always turn down the Volume control on your amplifier and then turn off its power before turning off other equipment.

**TIP** **Cables:** Always use good quality shielded cable for your instrument and small signal connections. Never use shielded or microphone cable for any speaker connections as this will not be substantial enough to handle the amplifier load and could cause damage to your amplifier system.

**TIP** **Caution:** These professional loudspeaker systems are capable of generating very high sound pressure levels. Use care with placement and operation to avoid exposure to excessive levels that can cause permanent hearing damage. (Refer to guidelines on the general warning & information sheet).

**TIP** **Servicing:** The user should not attempt to service these products. Refer all servicing to qualified service personnel.

## EFFECTS CONTROLS

The onboard digital effects have been custom designed by Laney to complement the AI+.

You have a choice of Reverb, Chorus, and Multi FX.

Reverb positions have a variety of decay times from Plate through Rooms to Hall. Chorus positions have a various of Lengths/Delays & Multi FX have a different blend of Reverb/Chorus/Delay on each position. These all need to be tried in conjunction with various Level Control settings to obtain your own unique sound.

Using the Send Control, your new sound can then be assigned fully to either Channel, or any split in between, external effects can be applied in the same way.

To add to the versatility of the Send Control, a mix of internal & external effects can be blended and applied to each Channel to give a much broader spectrum of sounds to choose from.

See the diagrams below/opposite for a visual explanation.

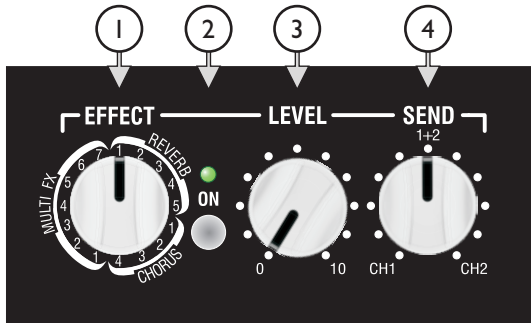

- ① Select the chosen effect here
- ② Turn on the onboard digital effects here, LED is lit when ON.
- ③ Sets the level of the effect chosen.
- ④ Applies the effect to the channels.

### Internal FX ON, no External FX connected

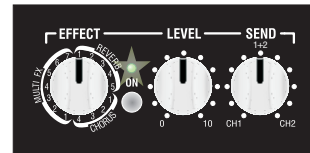

Internal FX applied equally to, CH1 - CH2

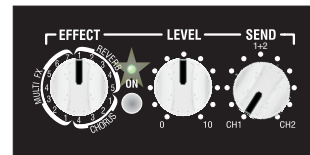

Internal FX, all CH1, none CH2

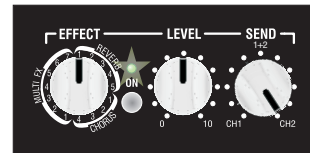

Internal FX, none CH1, all CH2



### Internal FX OFF, External FX connected

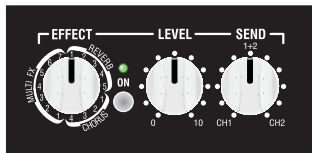

External FX applied  
equally to, CH1 - CH2

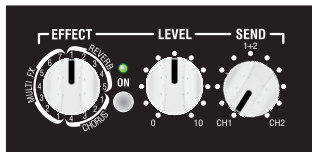

External FX, all CH2, none CH1

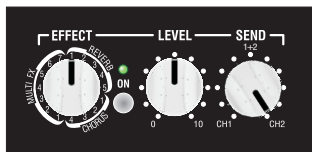

External FX, none CH2, all CH1

### Internal FX ON, External FX connected

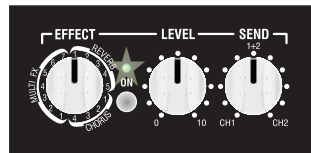

External / Internal  
equally to, CH1 - CH2

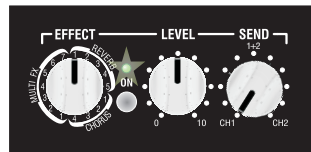

External CH2, Internal CH1

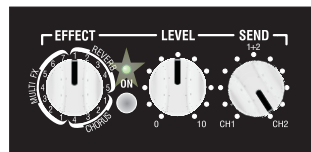

External CH1, Internal CH2

**TIP**

*If the effect push button (2) is enabled the footswitch will mute any (internal or external or both) effects that are applied to the amplifier*

**TIP**

*The really important thing is to experiment with the FX and Level controls. The cool sounds you discover can be noted in the user settings section.*

# USER SETTINGS

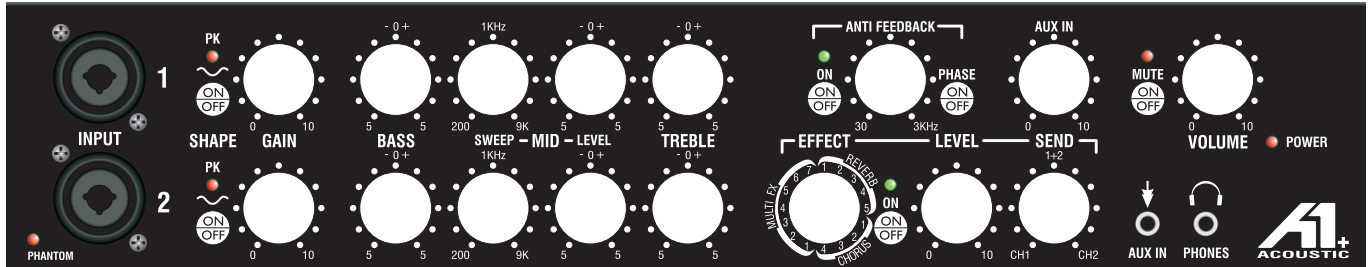

Notes:

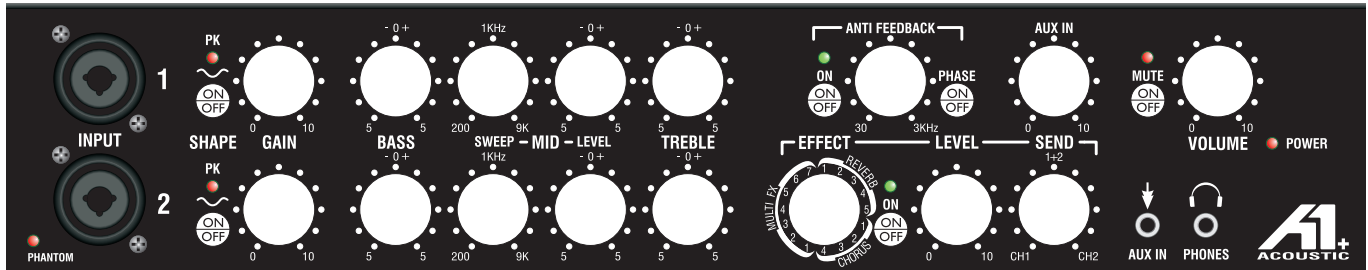

Notes:

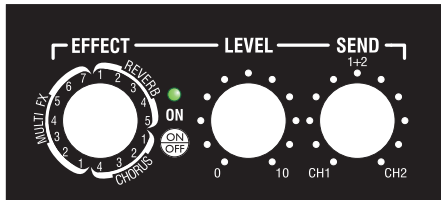

External FX:

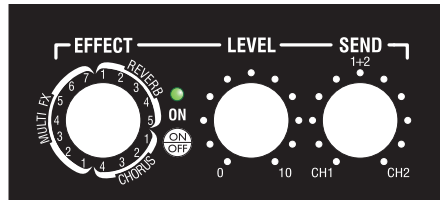

External FX:

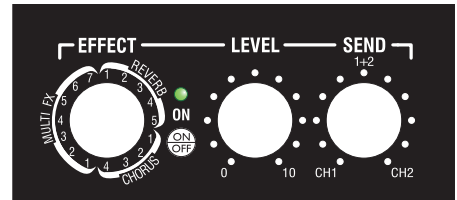

External FX:



# CONNECTIONS

Both channels are identical, connect a Guitar, Mic or 2nd Guitar etc. (XLR or 6.3 Jack)

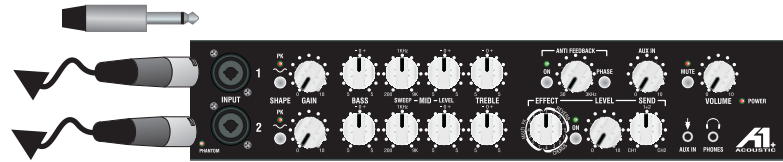

CD/MP3  
Player



Headphones



Use as  
Straight Combo

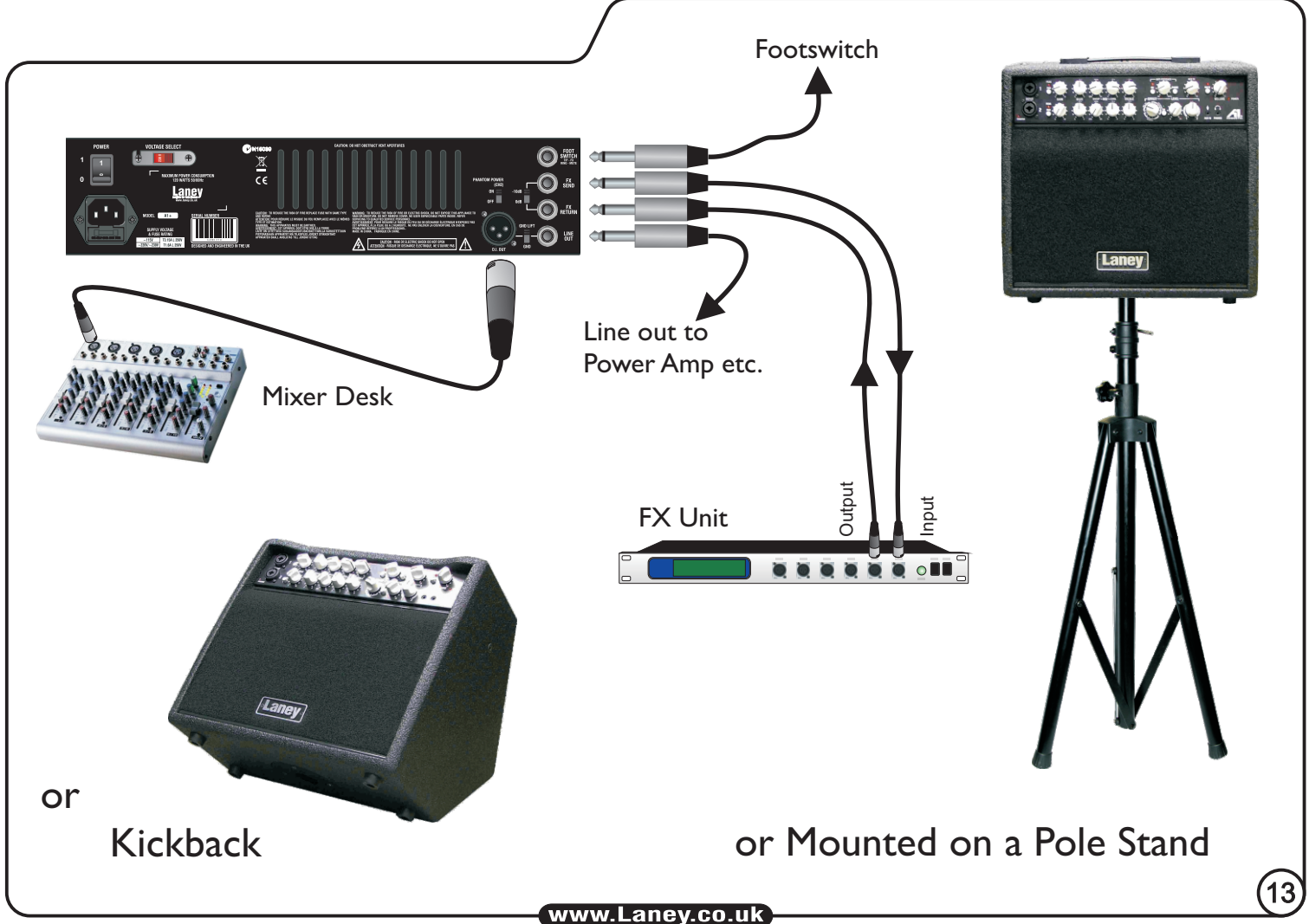

# BLOCK DIAGRAM

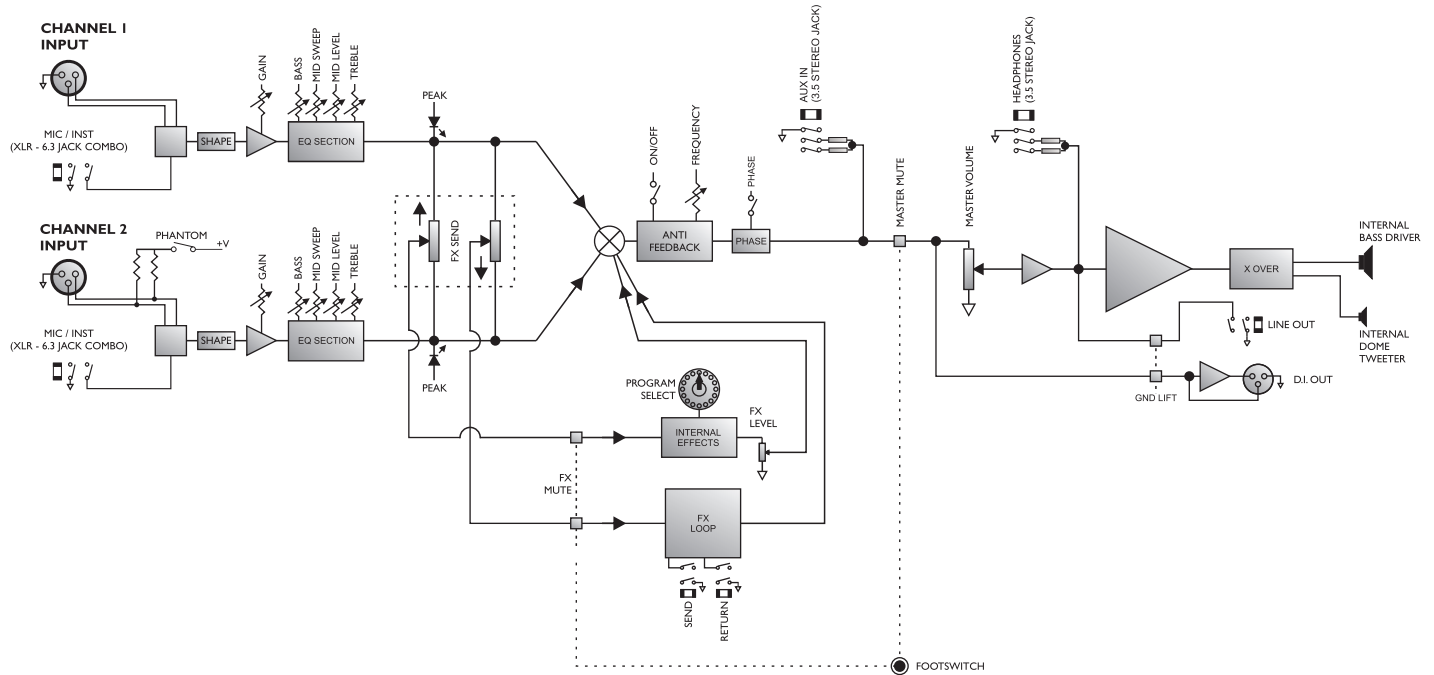

## SPECIFICATIONS

Supply Voltage	(~110V > ~120V), (~220V, > ~240V) 50/60Hz Via Selection Switch
Mains Fuse	(~110 > ~120V = T3.15A L 250V), (~220V>~240V = T1.6A L 250V).
Power Consumption	120W
Output Power Rating	80W
Loudspeaker	8" Custom Designed Bass Driver + 1" Domed Tweeter
Features	Input Combi Skts (6.3 Jack & XLR) Shape Switch Gain Bass ( $\pm 10\text{dB}$ at 70Hz, Shelving) Treble ( $\pm 15\text{dB}$ at 10KHz, Shelving) Mid-Paramid sweep ( $\pm 10\text{dB}$ at 200Hz > 9KHz Peaking) Anti Feedback Control (30Hz - 3KHz) Phase Switch High Quality Digital Signal Processor with 16 programs, Level Control & Send Aux In (3.5 Stereo Jack) with Level control Headphone Skt (3.5 Stereo Jack) Balanced XLR D.I. & Line Out (Ground Lift operates on both) FX Loop (Switchable 0dB / -10dB) Footswitch Skt (Laney FS2 required - FX Mute & Master Mute) Phantom Power +15V (CH2) Master Mute Master Volume Triple purpose kickback style cabinet with polyurethane coating, foam covered grill & pole stand skt
Size	348*387*312 (H*W*D)
Unit Weight	12.5Kg
Packing Weight	14.0Kg



This product conforms to the requirements of the following European Regulations, Directives & Rules:  
CE Mark (93/68/EEC), Low Voltage (72/23/EEC), EMC (2004/108/EEC),  
RoHS (2011/65/EU), WEEE (EU2002/96/EC)



In order to reduce environmental damage, at the end of its useful life, this product must not be disposed of along with normal household waste to landfill sites. It must be taken to an approved recycling centre according to the recommendations of the WEEE (Waste Electrical and Electronic Equipment) directive applicable in your country.

In the interest of continued development, Laney reserves the right to amend product specification without prior notification.

